

HARPIA

Comprehensive Spectroscopy System



The HARPIA comprehensive spectroscopy system performs a variety of sophisticated time-resolved spectroscopy measurements in a compact footprint. It also offers an intuitive user experience and easy day-to-day maintenance meeting the needs of today's scientific applications. Despite its small size, the HARPIA system is easily customizable and can be tailored to specific measurement needs.

The system is configured around the HARPIA-TA transient absorption spectrometer and can be expanded using time-correlated single-photon counting and fluorescence upconversion (HARPIA-TF), third beam delivery (HARPIA-TB) and microscopy modules. Switching between different measurement modes is mostly automated and requires very little user interaction.

Adhering to the standards set by the ORPHEUS product line, each module is contained in a single monolithic aluminium body ensuring excellent optical stability and minimal optical path lengths. For a robust and versatile single-supplier solution the HARPIA spectroscopy system can be combined with a PHAROS or a CARBIDE laser together with ORPHEUS series OPAs. HARPIA also supports Ti:Sa lasers with TOPAS series OPAs.

MEASUREMENT MODES:

- Femtosecond transient absorption and reflection
- Femtosecond transient absorption and reflection microscopy
- Femtosecond multi-pulse transient absorption and reflection
- Femtosecond fluorescence upconversion
- Picosecond-to-microsecond fluorescence using TCSPC
- Intensity-dependent transient absorption and reflection, time-resolved fluorescence
- Time-resolved femtosecond stimulated Raman scattering (FSRS)
- Flash photolysis

STANDARD CONFIGURATIONS

Ultrafast Transient Absorption, TCSPC and Fluorescence Upconversion Spectroscopy



Ultrafast Multi-pulse Transient Absorption Spectroscopy



Ultrafast Multi-pulse Transient Absorption, TCSPC and Fluorescence Upconversion Spectroscopy



HARPIA | TA

Ultrafast Transient Absorption Spectrometer

APPLICATION FIELDS

- Photochemistry
- Photobiology
- Photophysics
- Material science
- Semiconductor physics
- Time-resolved spectroscopy



The HARPIA-TA ultrafast transient absorption spectrometer features market-leading characteristics such as 0.05 mOD ($10^{-4} \Delta T/T$) sensitivity and the ability to work at high repetition rates up to 1 MHz, when used with a PHAROS or a CARBIDE laser and an ORPHEUS OPA. A high repetition rate allows measuring transient absorption dynamics, while exciting the samples with low pulse energies down to several nanojoules. Several probe configurations and detection options are available: from simple and cost-effective photodiodes for single-wavelength detection, to white-light supercontinuum probing, combined with spectrally-resolved broadband detection. HARPIA-TA features integrated data acquisition and measurement control electronics providing advanced features such as:

- Single (sample-only) or multiple (sample and reference) integrated spectral detectors
- Simple integration of an external spectrograph
- Automated pump and probe beam position tracking and alignment
- Straightforward switching between transient absorption and transient reflection measurements

Several delay line options are available to cover delay ranges from 2 ns to 8 ns using either linear leadscrew (20 mm/s) or fast ball-screw (300 mm/s) translation stages.

Various optomechanical peripherals and electronics are integrated in HARPIA including:

- Optical chopper which can be synchronized to an external trigger
- Motorized Berek polarization compensator to adjust the polarization of the pump beam
- Motorized translating supercontinuum generator (for use with CaF_2 or MgF_2)
- Automated sample mover to translate the sample in the focal plane, thus avoiding local sample overexposure
- Integrated computer and data acquisition electronics
- Sample stirrer
- Beam profiler

HARPIA-TA is compatible with many cryostats and peristaltic pumps. The capabilities of the spectrometer can be further extended using expansion modules.

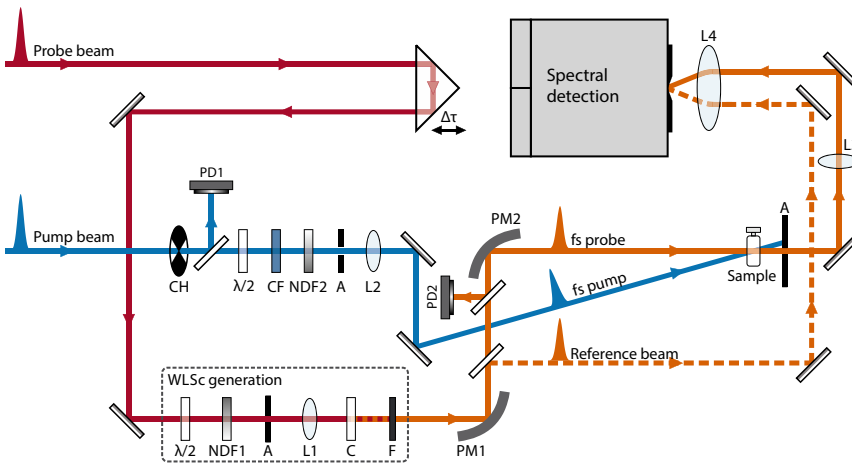

HARPIA-TA optical layout for pump-probe experiments

SPECIFICATIONS

Probe wavelength range, white light supercontinuum generator pumped by 1030 nm	480 – 1100 nm
Probe wavelength range, white light supercontinuum generator pumped by 515 nm	350 – 750 nm
Probe wavelength range, white light supercontinuum generator pumped by 800 nm	350 – 1100 nm
Spectral range of multichannel detectors	200 – 1100 nm, 700 – 1800 nm or 1.2 – 2.6 μm
Spectral range of single-channel detectors	180 nm – 24 μm
Delay range	4 ns, 6 ns or 8 ns
Delay resolution	4.2 fs, 6.3 fs or 8.3 fs
Laser repetition rate	1 – 1000 kHz
Time resolution	<1.4x of pump or probe pulse duration, whichever is longer
Physical dimensions, L×W×H	730 × 420 × 160 mm ¹⁾
Sample chamber area	205 × 215 mm

¹⁾ Without external spectrograph.

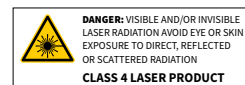

Custom cryostat mounting option

OUTLINE DRAWINGS

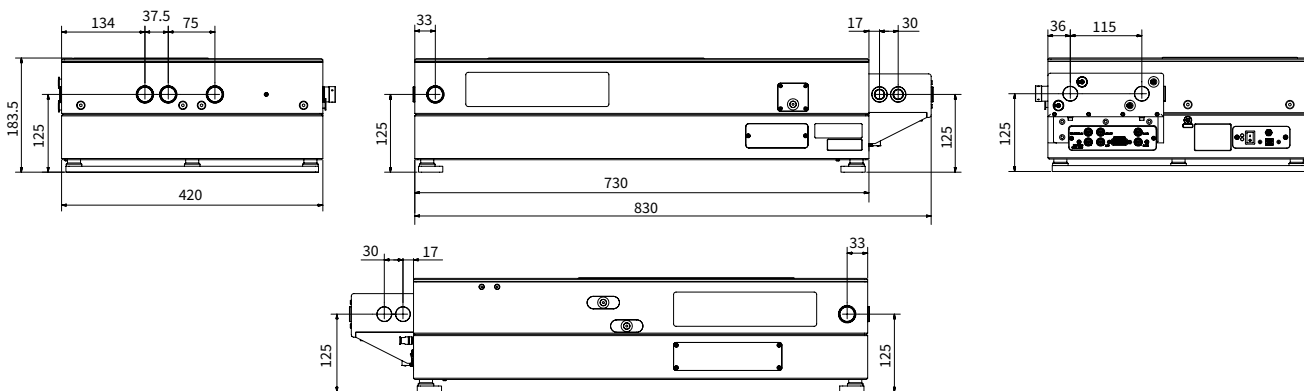

HARPIA-TA outline drawings

HARPIA | TF

Femtosecond Fluorescence Upconversion and TCSPC Module

FEATURES

- Combined femtosecond upconversion and TCSPC measurement in a small footprint
- Straightforward operation and easy day-to-day maintenance
- Works as an add-on to a HARPIA-TA or as a standalone unit
- Easy switching between fluorescence upconversion and TCSPC modes
- Compatible with PHAROS and CARBIDE series lasers running at 50 – 1000 kHz
- Analog PMT detector option for fluorescence upconversion
- Automated spectral scanning and calibration of upconversion crystal and prism
- Measurement of fluorescence dynamics in the femtosecond to microsecond range
- Full control over the following parameters of the pump beam:
 - Polarization (using a Berek polarization compensator)
 - Intensity (using manual or automated continuously variable neutral density filters)
 - Gate delay (using an optical delay line)
- Spectrally-resolved fluorescence detection using a monochromator
- When combined with a HARPIA-TA main unit, a single monochromator can be used for both time-resolved absorption and fluorescence measurements with no detector swapping necessary. Other monochromator options are available, such as a double subtractive monochromator for higher TCSPC time resolution



The HARPIA-TF is a time-resolved fluorescence measurement module which combines fluorescence upconversion and TCSPC techniques. In fluorescence upconversion, the signal from the sample is mixed in a nonlinear crystal with a gating femtosecond pulse to achieve high temporal resolution, which is limited by the duration of the gate pulse and is in the range of 250 fs. For fluorescence decay times exceeding 150 ps, the instrument can be used in time-correlated single-photon counting (TCSPC) mode to measure kinetic traces in the 200 ps – 2 μs range. The HARPIA-TF module supports Becker&Hickl TCSPC devices and detectors.

The combination of these two time-resolved fluorescence techniques enables the measurement of spectrally-resolved fluorescence decay in the femtosecond to microsecond range. With the use of a high repetition rate PHAROS or CARBIDE laser, the fluorescence dynamics can be measured while exciting the samples with low pulse energies down to several nanojoules.

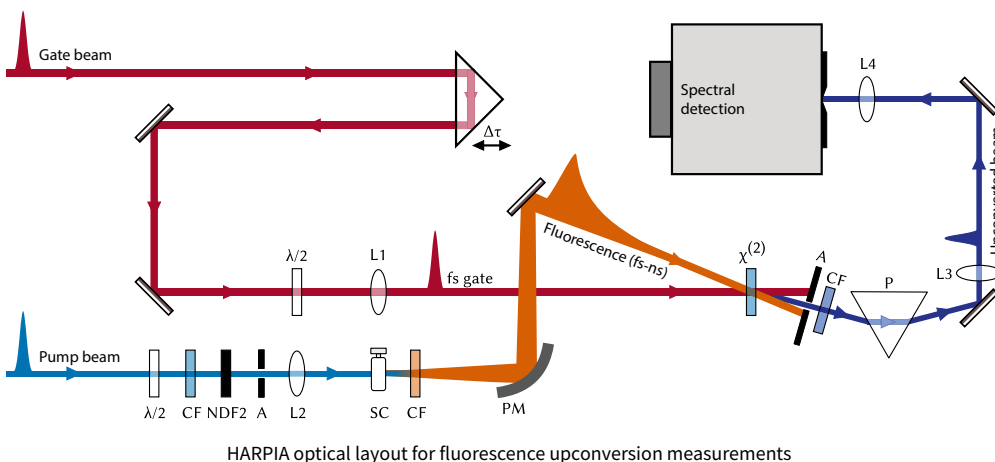

HARPIA optical layout for fluorescence upconversion measurements

SPECIFICATIONS

TCSPC MODE

TCSPC module	Becker&Hickl SPC 130 ¹⁾
Photomultiplier	Becker&Hickl PMC-150 or HPM-100
Emission wavelength range	300 – 820 nm
Intrinsic time resolution	<200 ps
Time resolution with monochromator	<1.2 ns ²⁾
SNR	< 100 : 1, assuming 5 s averaging per trace ³⁾

UPCONVERSION MODE

Wavelength range	300 – 1600 nm ⁴⁾
Wavelength resolution	Limited by the bandwidth of the gating pulse, typically around 100 cm ⁻¹
Delay range	4 ns, 6 ns or 8 ns
Delay resolution	4.2 fs, 6.3 fs or 8.3 fs
Time resolution	< 1.4× of the pump or probe pulse duration, whichever is longer, 420 fs with a PHAROS laser ⁵⁾
SNR	65:1, assuming 0.5 s averaging per point ⁶⁾

¹⁾ Visit www.becker-hickl.de for specifications.

²⁾ Estimated as the FWHM of the upconverted white-light supercontinuum generated in the sample.

³⁾ Estimated by fitting a kinetic trace measured in Rhodamine 6G solution at 580 nm with multiple exponents, subtracting the fit from the data and taking the ratio between the standard deviation of the residuals and the 0.5 × maximum signal value. Laser repetition rate 250 kHz. Not applicable to all samples and configurations.

⁴⁾ Depending on the gating source, full range covered with different nonlinear crystals.

⁵⁾ Estimated as the FWHM of the upconverted white-light supercontinuum generated in the sample or the derivative of the rise of the upconversion signal.

⁶⁾ Estimated as the standard deviation of a set of 100 points at 50 ps intervals measured in Rhodamine 6G dye at an upconverted wavelength of 360 nm using a PHAROS laser running at 150 kHz repetition rate. Not applicable to all samples and configurations.

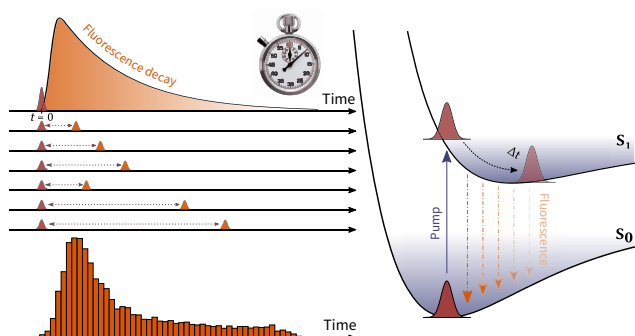
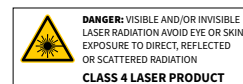

Principle of time-correlated single-photon counting (TCSPC)

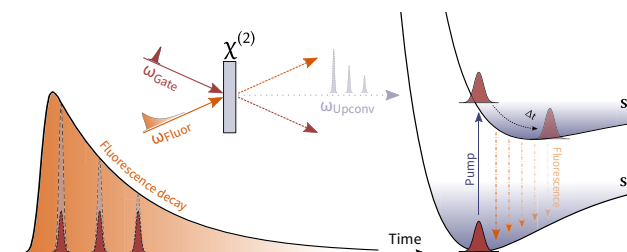

Principle of time-resolved fluorescence upconversion

HARPIA | TB

Third Beam Delivery Module

FEATURES

- Can be installed as an add-on to a HARPIA-TA
- Provides an additional temporal dimension to pump-probe measurements
- Provides additional insight into complex photodynamic systems
- Full control of the third beam:
 - Polarization (using a manual or automated Berek polarization compensator)
 - Intensity (using a manual or an automated continuously variable neutral density filter)
 - Delay (using an automated 2 ns or 4 ns optical delay line)
- Z-scan support



When standard spectroscopy tools are not enough to unravel the intricate ultrafast dynamics of photoactive systems, multi-pulse time-resolved spectroscopic techniques can be utilized to yield additional insight. The HARPIA-TB is a third beam delivery module for the HARPIA-TA main unit that adds an additional dimension to time-resolved absorption measurements. It allows an additional temporally-delayed laser pulse to be introduced before or during the pump-probe interaction in order to perturb the ongoing photodynamics.

In a pump-dump-probe (PDP) configuration, an auxiliary pulse resonant to a stimulated emission transition band can deliberately depopulate the excited state and thereby revert the excited system back to the ground state.

In a pump-repump-probe (PrPP) configuration, the wavelength of the additional pulse corresponds to an induced absorption resonance and thus is able to elevate the system to a higher excited state (which may or may not be detectable in the nonperturbed photoevolution), or return it to an earlier transient state.

In a pre-pump-pump-probe (pPPP) configuration, the auxiliary pulse is resonant to an electronic ground-to-excited state transition, i.e., $S_0 \rightarrow S_n$, which makes it possible to either replenish the excited state population or to prepare a small portion of the excited state population before the main pump pulse.

Since the probe and the auxiliary pulse can be delayed in time with respect to each other, kinetic trace and action trace experiments can be performed using a HARPIA-TB module. In kinetic trace mode, the evolution of the system perturbed by the additional pulse is tracked by scanning the time delay of the probe pulse. In action trace mode, the influence of the exact timing of the perturbation is investigated by scanning the delay of the additional pulse.

Moreover, HARPIA-TB can be utilized to deliver frequency-narrowed picosecond pulses, thus providing the capability to perform time-resolved femtosecond stimulated Raman scattering (FSRS) measurements.

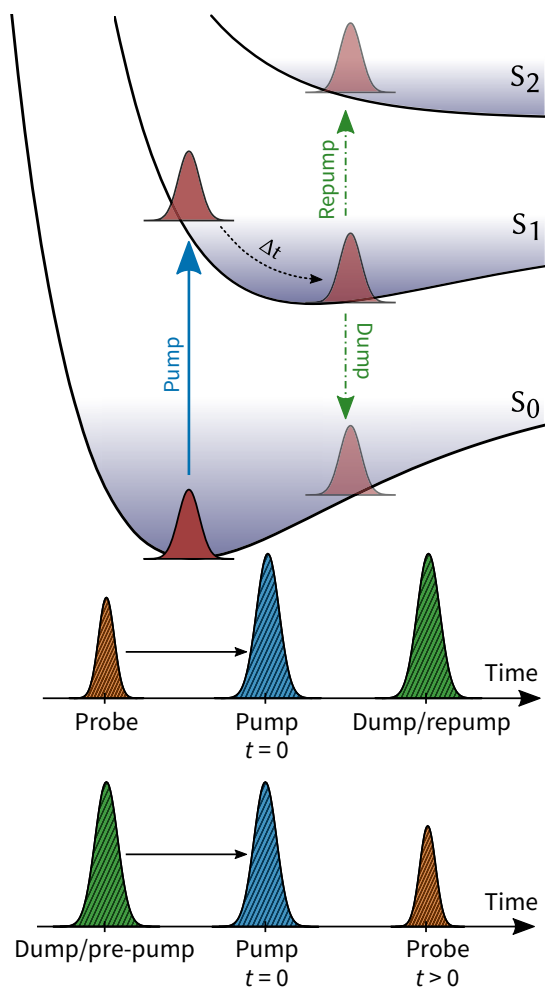

State transitions and pulse timing in multi-pulse time-resolved transient absorption spectroscopy

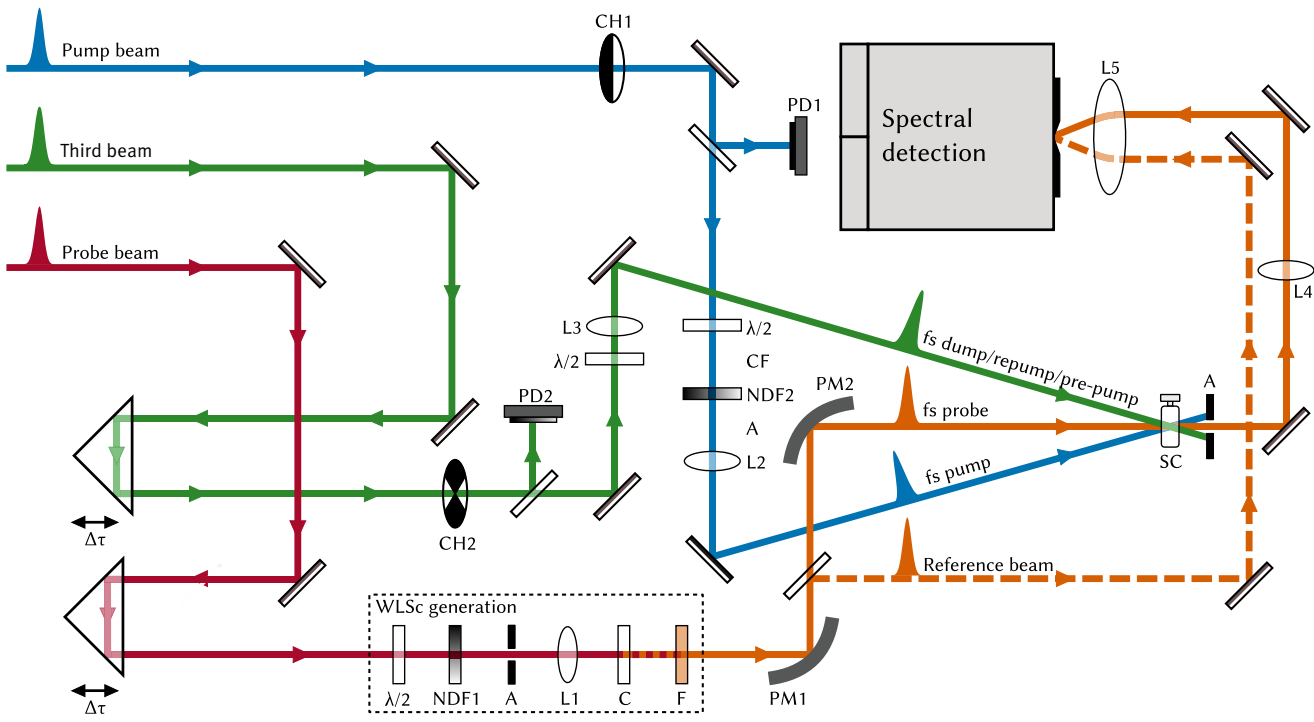

HARPIA optical layout for multi-pulse experiments

OUTLINE DRAWINGS

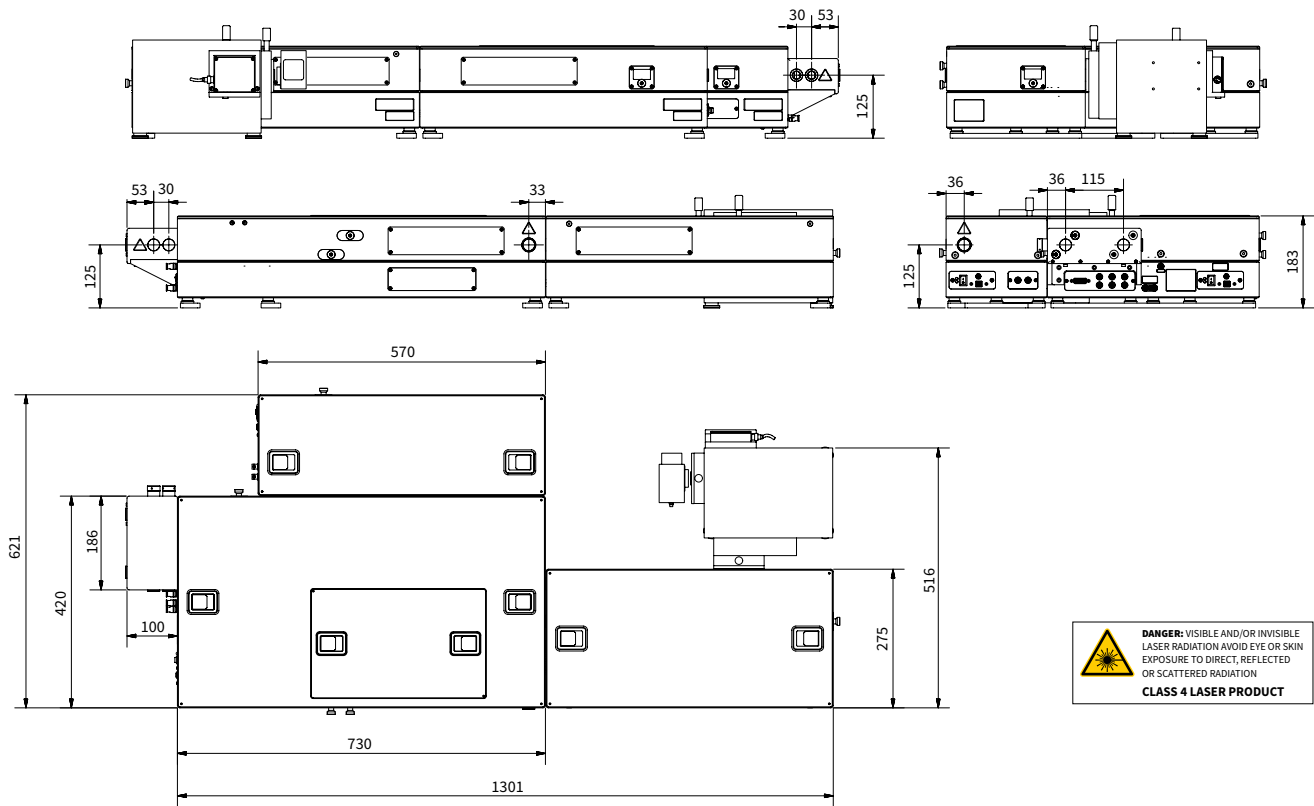

Outline drawings of HARPIA system with HARPIA-TB and HARPIA-TF modules

HARPIA

Microscopy Module



The microscopy module is an add-on to a standard HARPIA-TA body and enables spatially-resolved pump-probe measurements with a sub-5 μm resolution. Broadband and monochromatic probe beam options are supported. The user can switch between bulk and microscopic pump-probe modes without disturbing the sample by swapping self-contained bulk and microscopy modules that are mounted on kinematic bases. A 3D motorized stage allows the sample to be positioned and scanned in a $13 \times 13 \times 13 \text{ mm}^3$ volume. Samples of various thicknesses can be accommodated using an optional motorized objective stage. The sample holder comes with cassettes for various sample types and sizes. The module can be configured in either transmission or reflection geometry, and the sample can be observed using a conventional brightfield mode to determine the pump-probe spot position.



SPECIFICATIONS

Spatial resolution	5 μm
Working distance	15 mm
Spectral range	480 – 1100 nm
Temporal resolution	500 fs
Sample motion range	$13 \times 13 \times 13 \text{ mm}^3$



Switching between bulk and microscopic pump-probe modes can be done without disturbing the sample

TRANSMISSION MODE

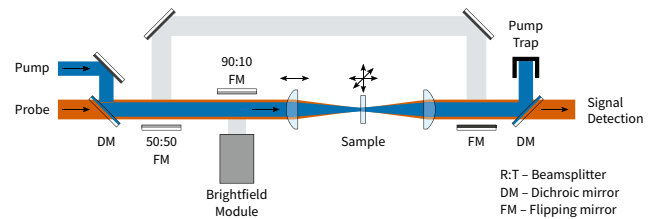

REFLECTION MODE

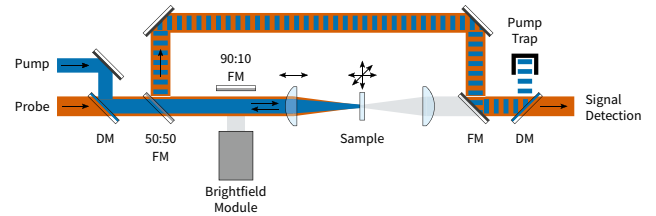

BRIGHTFIELD MODE

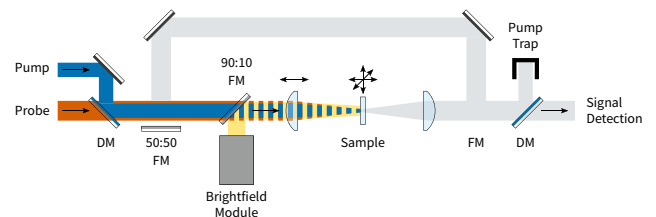

HARPIA Software

HARPIA SOFTWARE

A single application for transient absorption, fluorescence upconversion and TCSPC measurements, featuring:

- Intuitive and user-friendly interface
- Wizards to guide measurements and calibration
- Measurement presets
- Optional advanced measurement post-processing (data balancing for noise suppression, signal saturation detection, outlier detection, etc.)
- Diagnostics and data export tools
- REST API for remote experiment control using third-party software
- API examples using LabView, Python and MATLAB
- Automatic software update

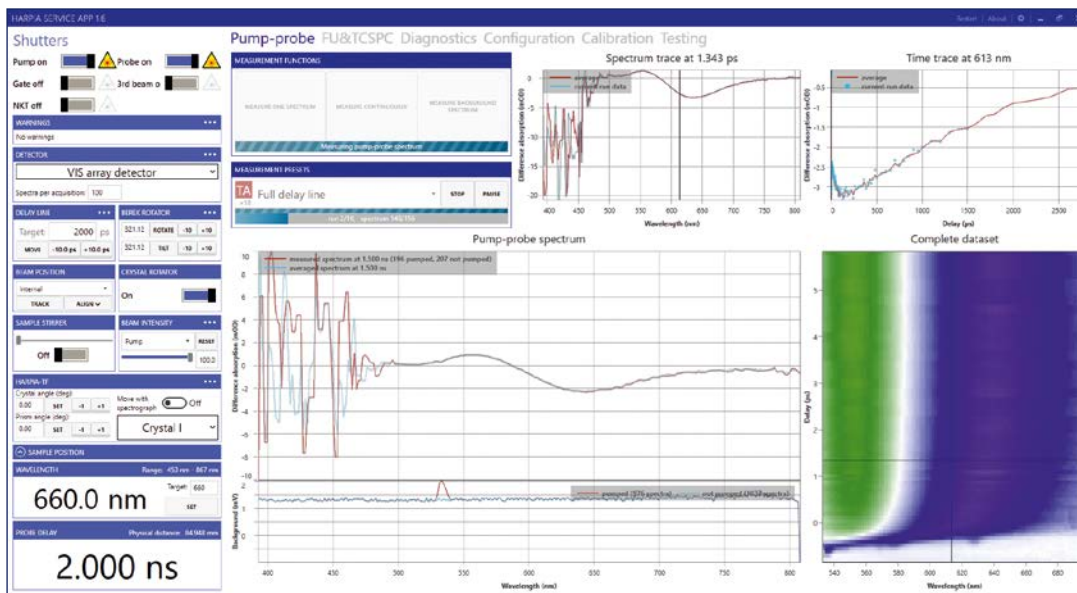

HARPIA Software main window

CARPETVIEW DATA ANALYSIS SOFTWARE

An advanced ultrafast spectroscopy data analysis application, featuring:

- Advanced visualization and data export tools
- Publication-quality graph preparation
- Advanced data wrangling: slicing, merging, cropping, shifting, smoothing, fitting, subtracting, etc.
- Probe spectral chirp correction and calibration using a reference transient absorption spectrum
- Advanced global and target analysis:
 - Fitting to user-defined physical compartment model
 - Probe spectral chirp correction and deconvolution with an instrument response function
- Support for three-dimensional data sets (2D electronic spectroscopy, fluorescence lifetime imaging)

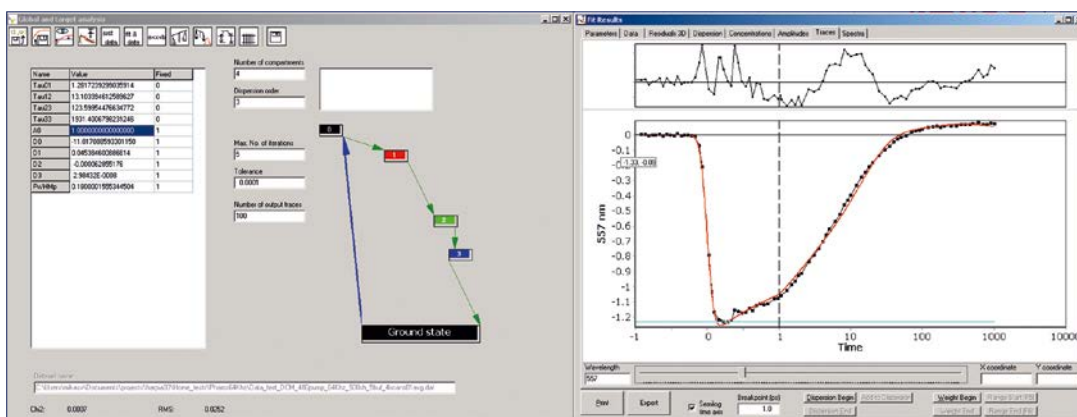

Global and target analysis window of CarpetView

HARPIA Data Samples

FEMTOSECOND PUMP-PROBE

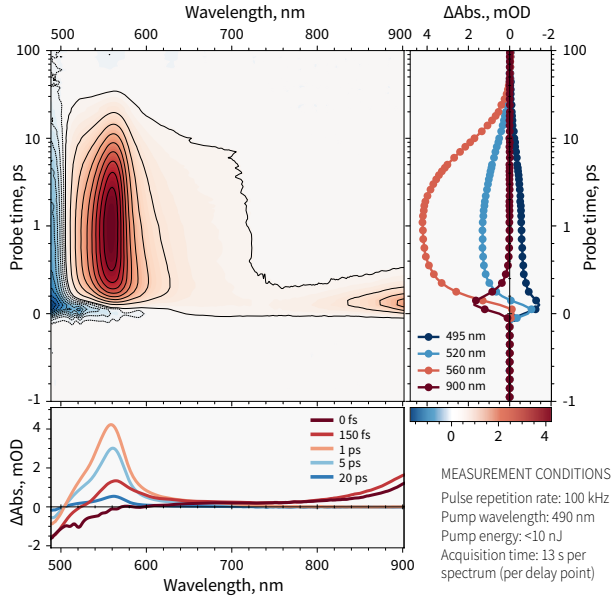

Spectral dynamics of beta-carotene in solution acquired using HARPIA-TA

FLUORESCENCE UPCONVERSION

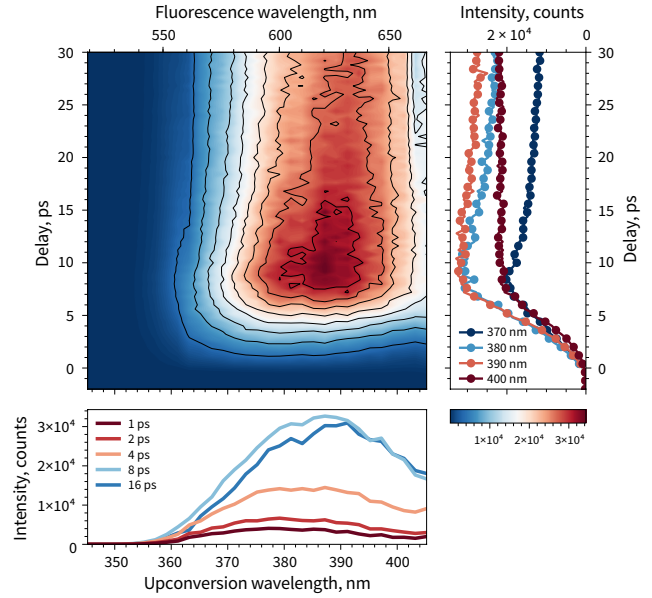

Fluorescence dynamics of DCM laser dye in solution acquired using HARPIA-TF in fluorescence upconversion mode

FEMTOSECOND PUMP-PROBE MICROSCOPY

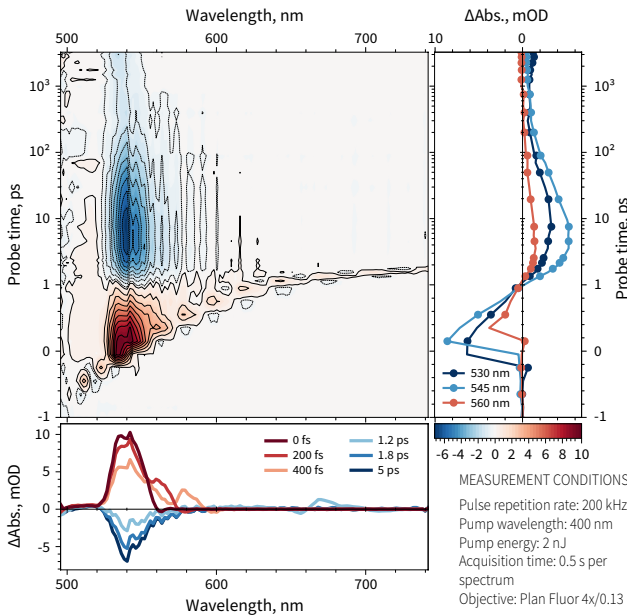

Single perovskite crystallite pump-probe spectral kinetics, pump at 400 nm

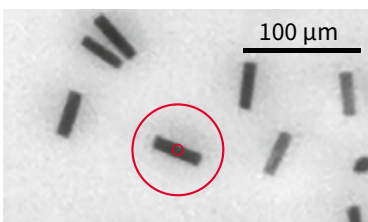

Pump-probe spot marked by the small circle

HARPIA PERFORMANCE AT HIGH REPETITION RATES

The HARPIA spectroscopy system achieves an excellent signal-to-noise ratio at high repetition rate and low energy excitation conditions. The graphs below compare the SNR of difference absorption spectra obtained with a Ti:Sapphire laser running at 1 kHz and a PHAROS laser running at 64 kHz with the same acquisition time.

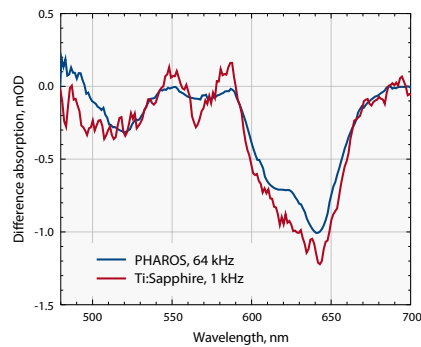

Measured difference absorption spectra of CdSe/ZnS quantum dots using low- and high-repetition rate lasers with 5 s acquisition time

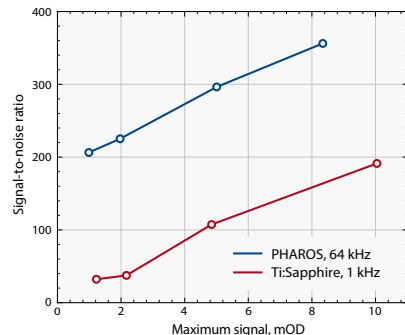

Best-effort signal-to-noise ratios, achieved with HARPIA-TA spectrometer driven by a Ti:Sapphire laser operating at 1 kHz (red) and a PHAROS laser operating at 64 kHz (blue)

IR FEMTOSECOND PUMP-PROBE

Pump-probe dynamics of GaAs wafer in IR measured using signal and reference single-channel detectors

MEASUREMENT CONDITIONS
 Pulse repetition rate: 75 kHz
 Pump wavelength: 700 nm
 Acquisition time: 1 s per point

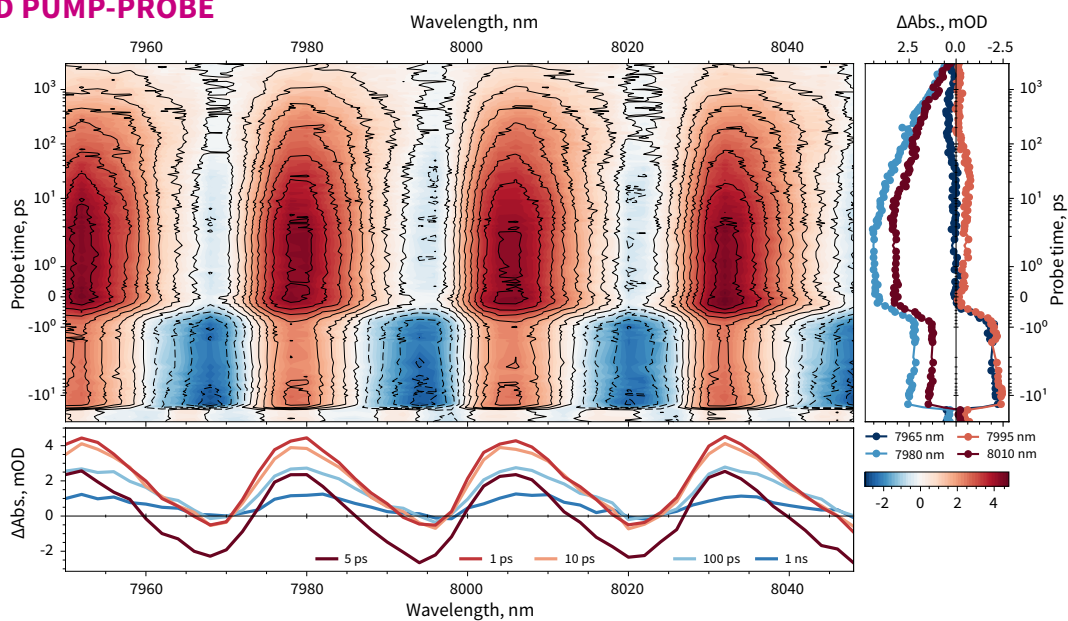

FEMTOSECOND PUMP-DUMP-PROBE

Pump-dump-probe dynamics of DCM laser dye with dump pulse resonant to the emission band of DCM

MEASUREMENT CONDITIONS
 Pulse repetition rate: 50 kHz
 Pump wavelength: 515 nm
 Dump wavelength: 700 nm
 Dump delay: 21 ps
 Pump energy: 90 nJ
 Dump energy: 190 nJ

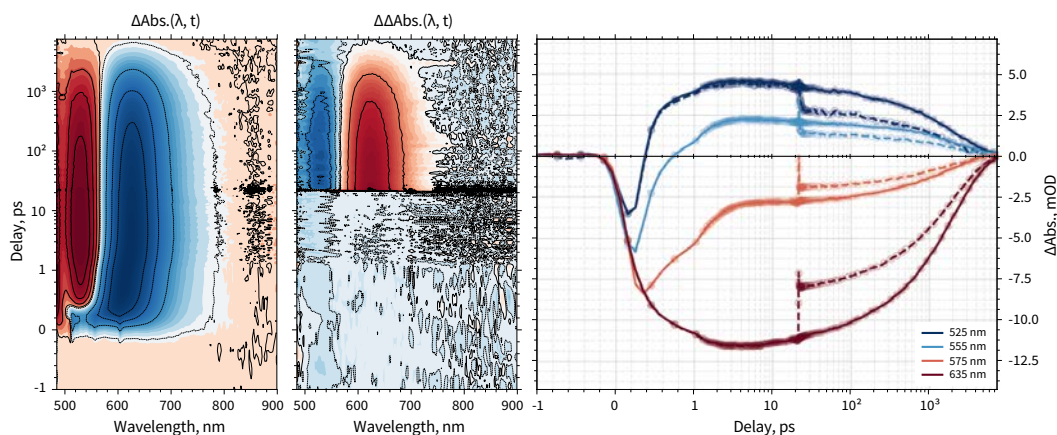

FLASH PHOTOLYSIS

Nanosecond spectral dynamics of meso-Tetraphenylporphine in solution acquired using HARPIA in flash photolysis mode

MEASUREMENT CONDITIONS
 Pulse repetition rate: 1.8 kHz
 Pump wavelength: 343 nm
 Pump energy: 5.4 μJ

